

产品使用说明书

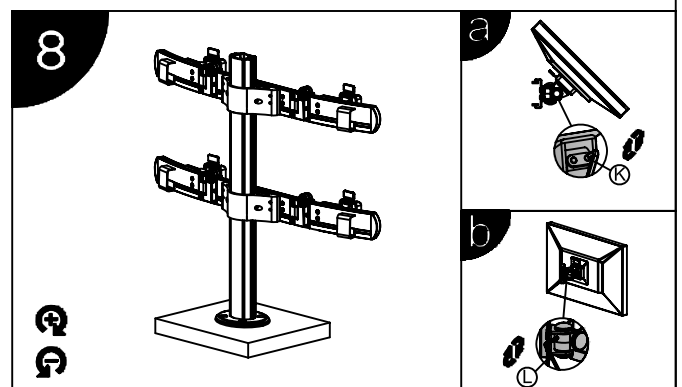

产品型号: L400

安装步骤

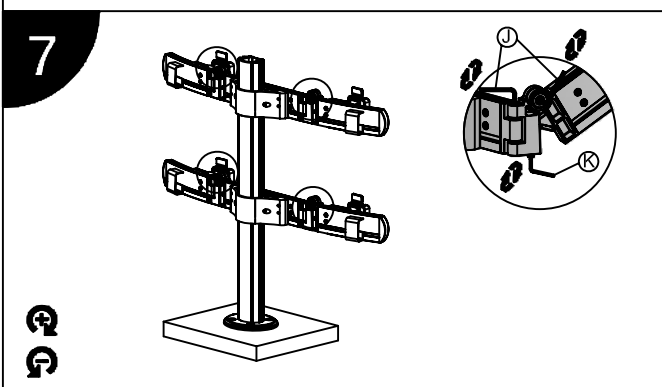
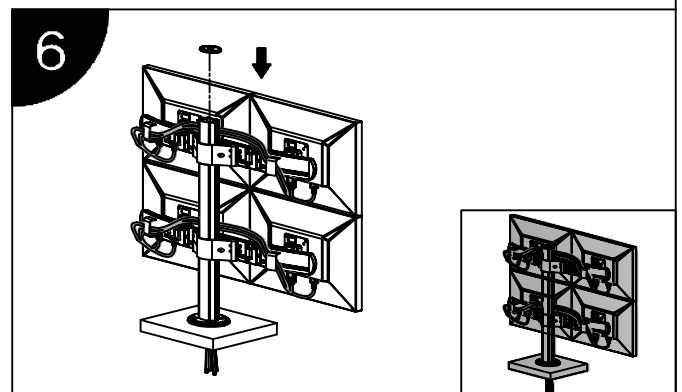
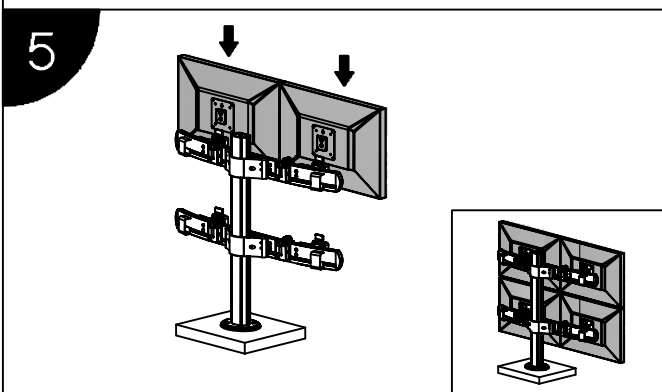
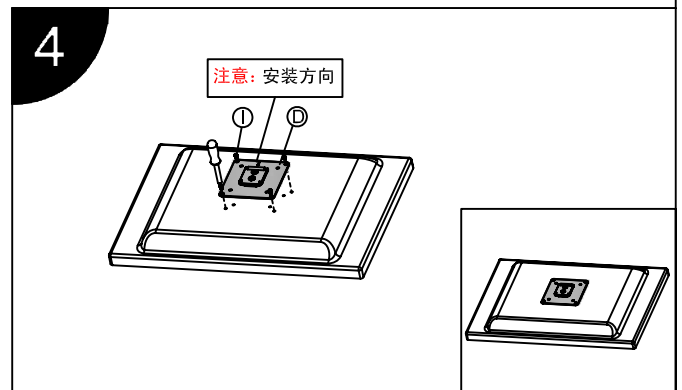
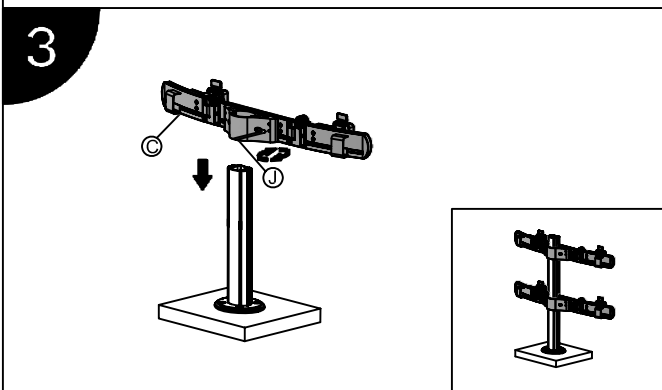
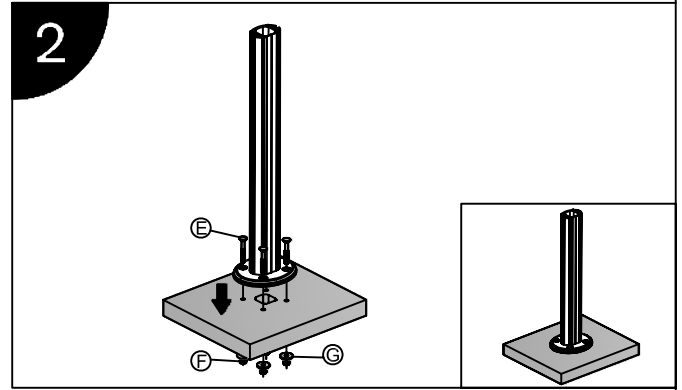
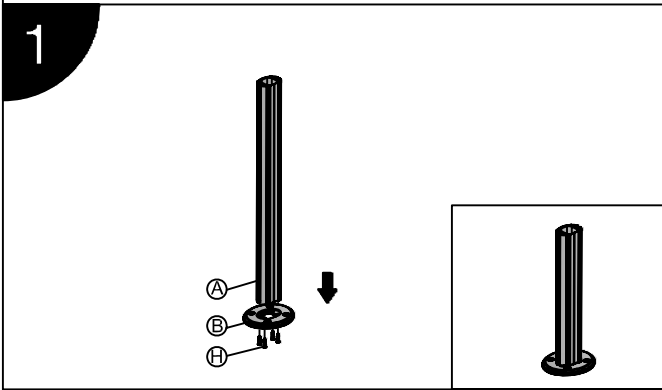

产品使用说明书

产品型号：L400

标准配件			
序号	示图	规格	数量
A			1
B			1
C			2
D			4
E		M8*60	4
F		M8螺帽	4
G		M8垫片	4
H		M5*25	4
I		M4*12	16
J		M5	1
K		M4	1
L		M3	1