

产品使用说明书

产品型号: L200

安装步骤

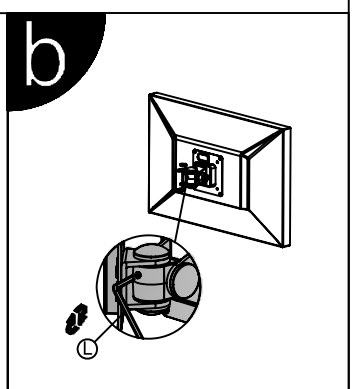
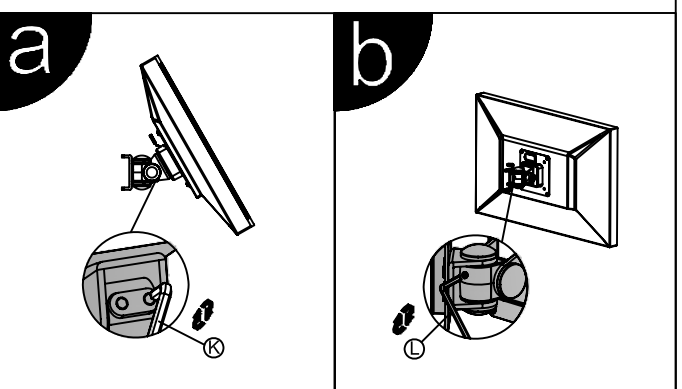
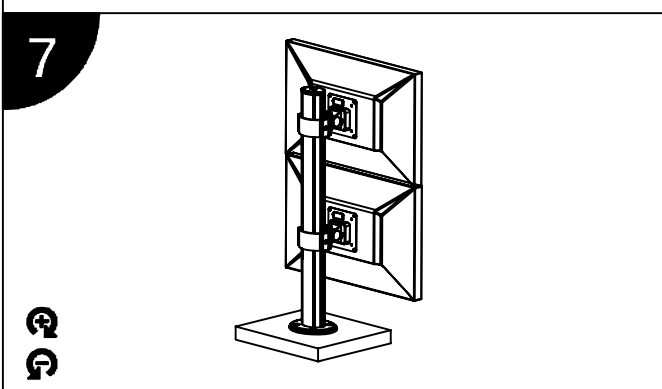
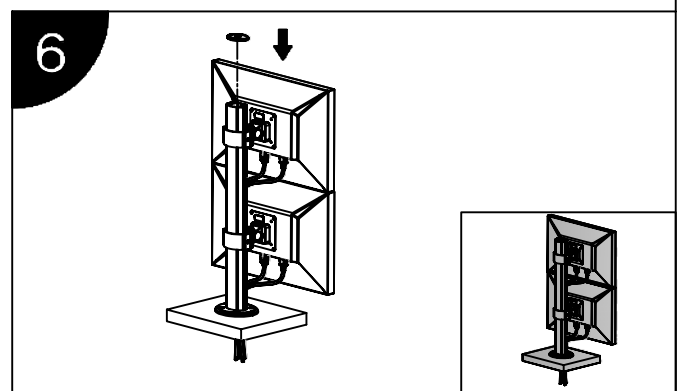
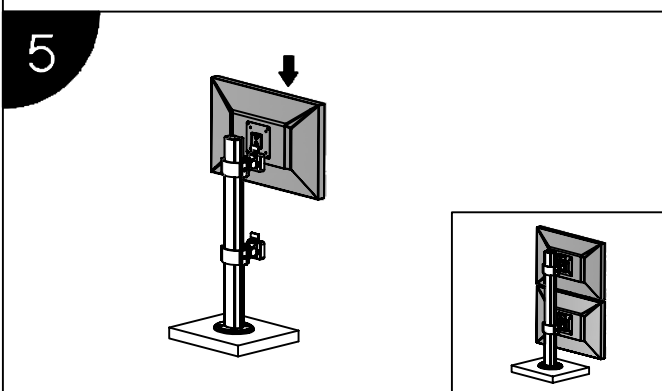
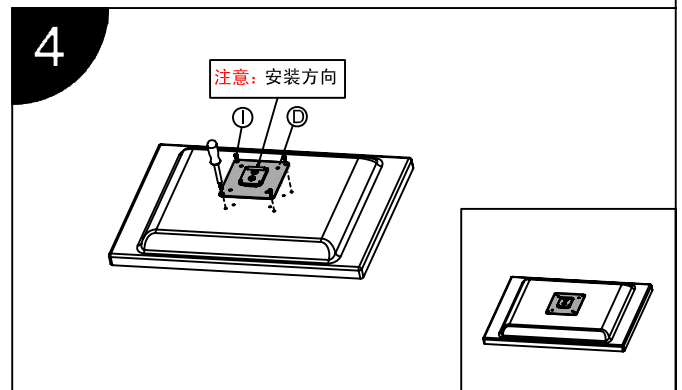
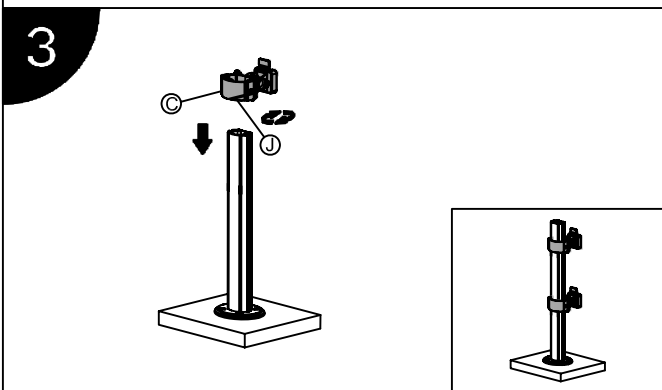
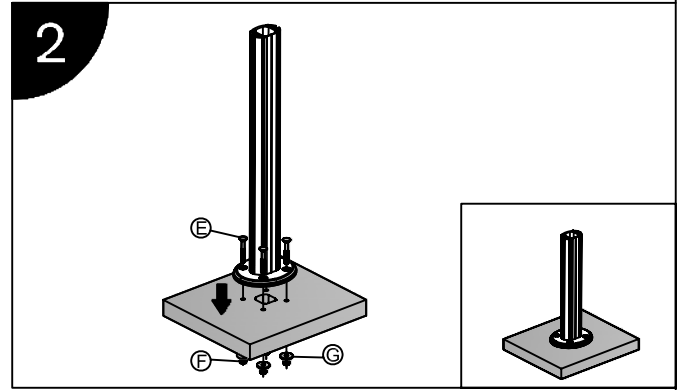
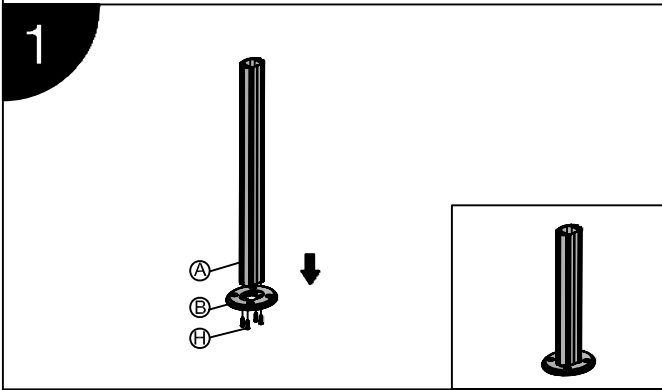

产品使用说明书

产品型号：L200

标准配件			
序号	示图	规格	数量
A			1
B			1
C			2
D			2
E		M8*60	4
F		M8螺帽	4
G		M8垫片	4
H		M5*25	4
I		M4*12	8
J		M5	1
K		M4	1
L		M3	1