

## Installation Manual

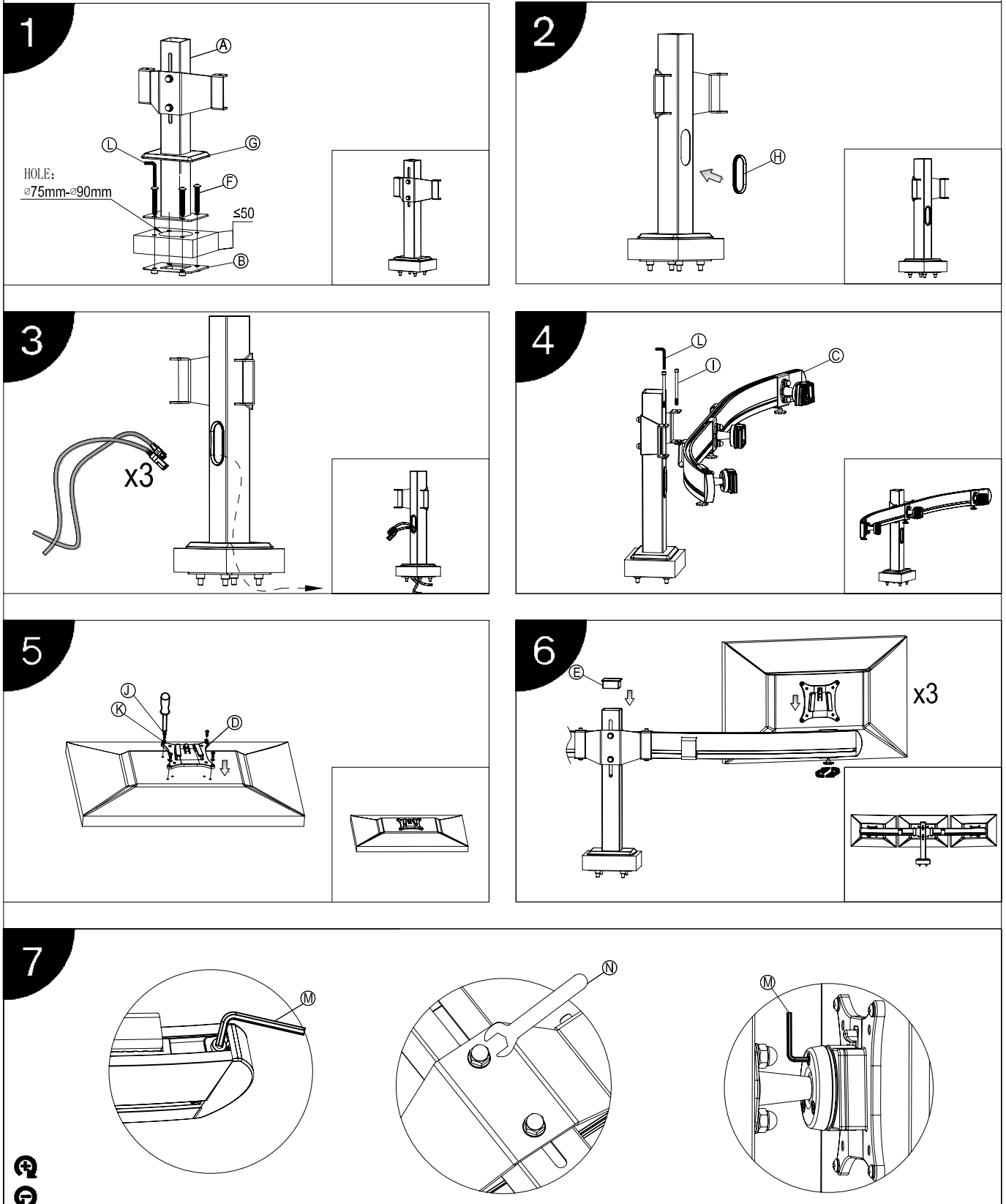









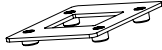

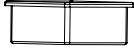
Model No.: BL300

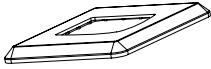
### Installation Steps

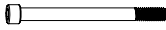

## Installation Manual

Model No.: BL300

Parts list			
No.	ITEM	SPECS	QUANTITY
A			1
B			1
C			1
D			3
E			1
F		M8*65	4
G			1
H			1
I		M6*80	2
J		M4*12	12
K		M4	12
L		M5	1
M		M3	1
N		M8	1