

产品使用说明书

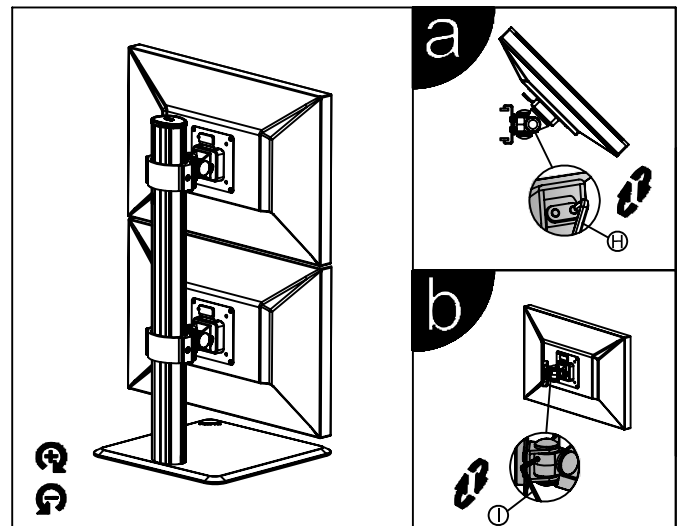

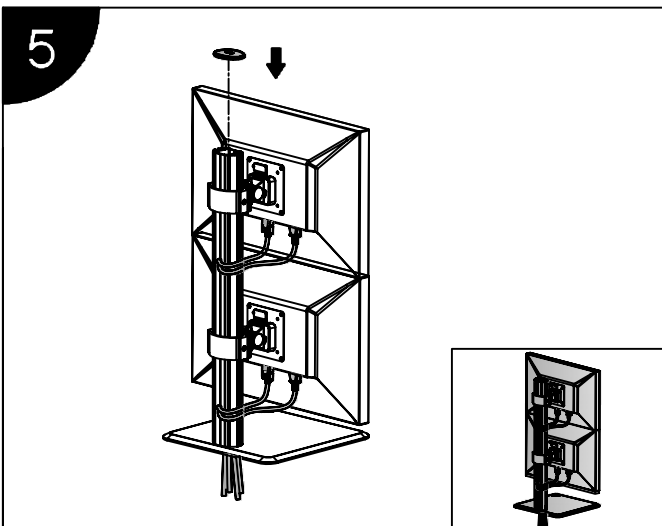

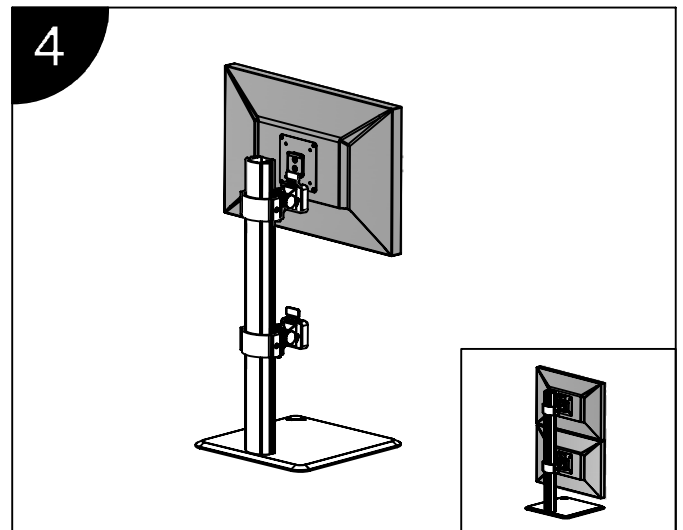

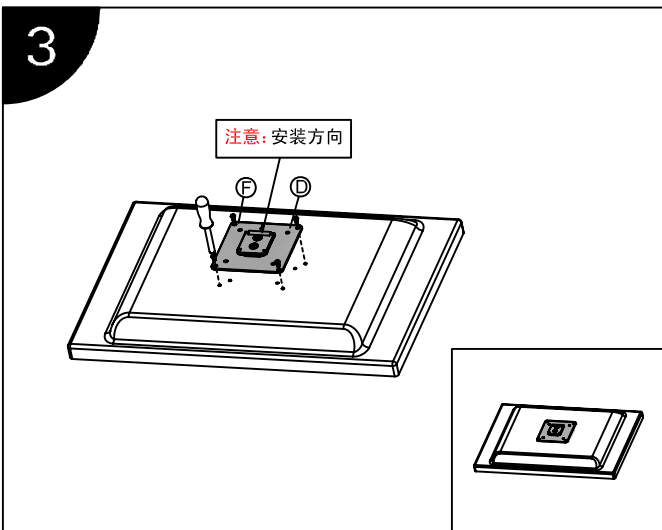
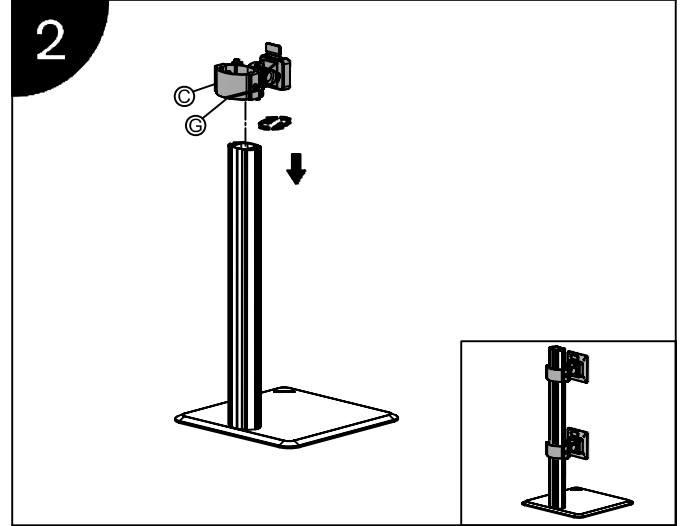
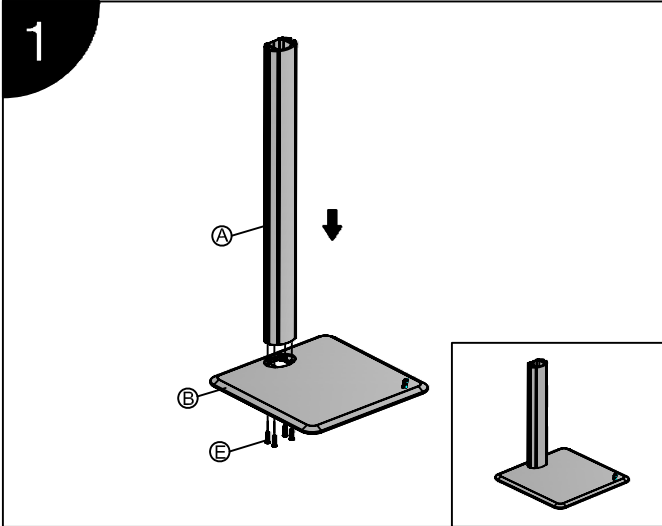

产品型号: L201

安装步骤



产品使用说明书

产品型号：L201

标准配件			
序号	示图	规格	数量
A			1
B			1
C			2
D			2
E		M5*25	4
F		M4*12	8
G		M5	1
H		M4	1
I		M3	1